





about us

A Wide Range of Colors...for one gorgeous home

Nothing brings a home's exterior to life like gorgeous shutters. They not only complement a home's windows, they also provide another dimension of beauty and vibrancy.

It's why at Mid-America, we offer an industry-leading color palette. Our shutters come in a variety of colors and styles, making it easy to complement any home.

Raised Panel Shutters



WIDTHS 14 3/4"

LENGTHS 31", 35", 39", 43",
47", 51", 55", 59",
63", 67", 71", 75",
80"

PICTURED IN FEDERAL BROWN #009

Louver Shutters



WIDTHS 14 1/2"

LENGTHS 25", 31", 36", 39",
43", 48", 52", 55",
60", 64", 67", 72",
75", 80"

PICTURED IN CLAY #008

Shutter Colors

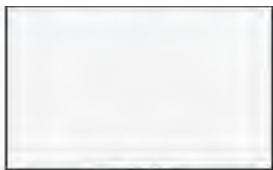

White
001



Black
002

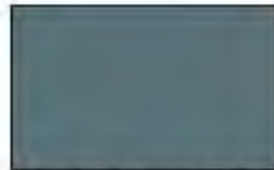

Wedgewood
Blue 004

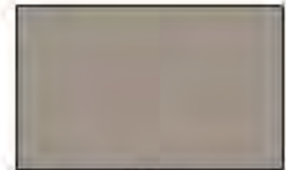

Clay
008

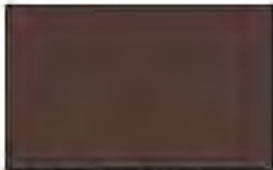

Federal Brown
009

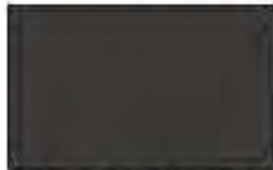

Musket Brown
010



Tuxedo Grey
018



Wicker
023

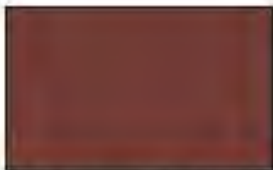

Burgundy Red
027



Forest Green
028

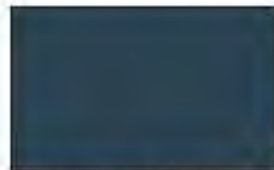

Classic Blue
036

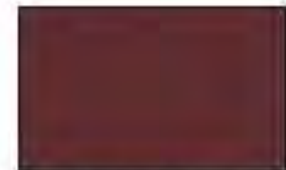

Wineberry
078



Midnight Green
122

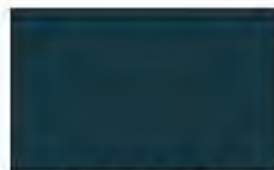

Midnight Blue
166

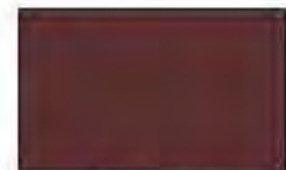

Bordeaux
167

Board-n-Batten Shutters



3-BOARD SPACED

WIDTHS 14"

LENGTHS 31", 35", 39", 43",
47", 51", 55", 59",
63", 67", 71", 75",
80"

PICTURED IN WEDGEWOOD BLUE #004

Board-n-Batten Shutters

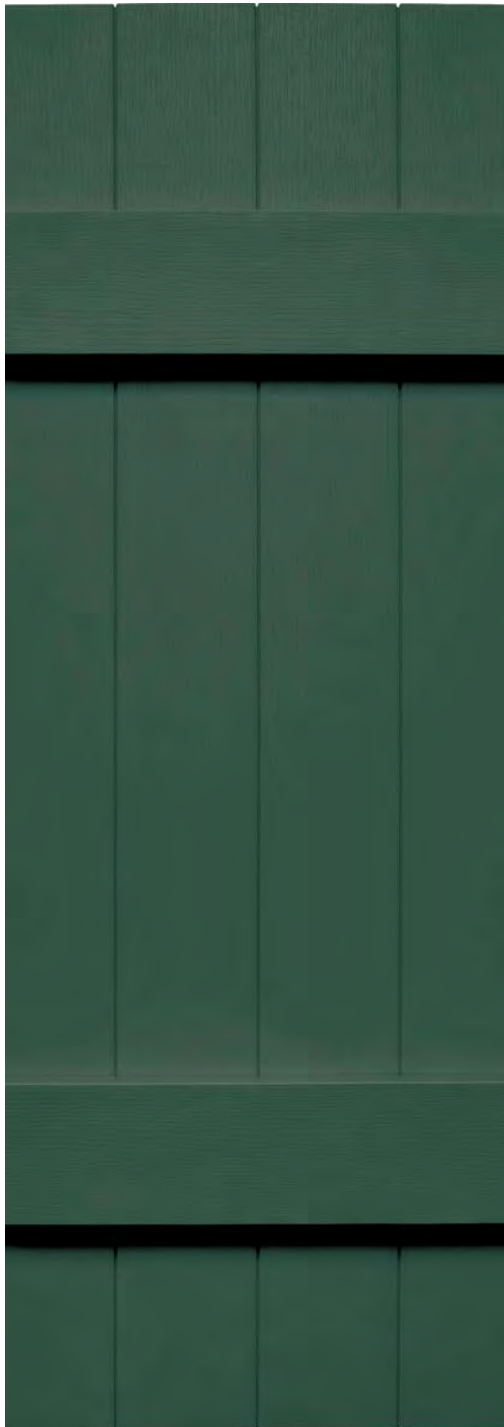

4-BOARD JOINED

WIDTHS 14"

LENGTHS 31", 35", 39", 43",
47", 51", 55", 59",
63", 67", 71", 75",
80"

PICTURED IN FOREST GREEN #028

Board-n-Batten Shutters



PICTURED IN MUSKET BROWN #010

4-BOARD JOINED W/ARCH TOP

WIDTHS 14"

LENGTHS 45", 49", 53", 57",
61", 65", 69", 73",
77", 81", 85", 89",
94"

When ordering 4-Board Joined with Arch Top shutters add 7" to the window opening height to determine total shutter height. For example: 50" high window opening + 7" arch = 57" shutter.

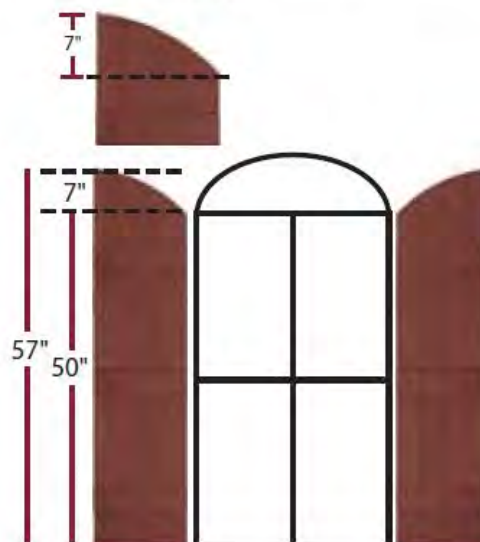

Shutter Accessories



PICTURED IN BURGUNDY #027

QUARTER ROUND ARCH TOP
RAISED PANEL
WIDTHS 14 3/4"

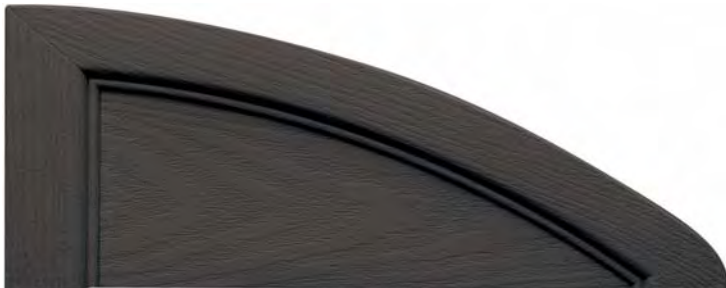

PICTURED IN TUXEDO GREY #018

ELLIPTICAL
WIDTHS 14 3/4
HEIGHT 6"

USE WITH RAISED PANEL ONLY

Shutter Accessories



TRANSOM TOP RAISED PANEL

WIDTHS 14 3/4"

PICTURED IN WINEBERRY #078

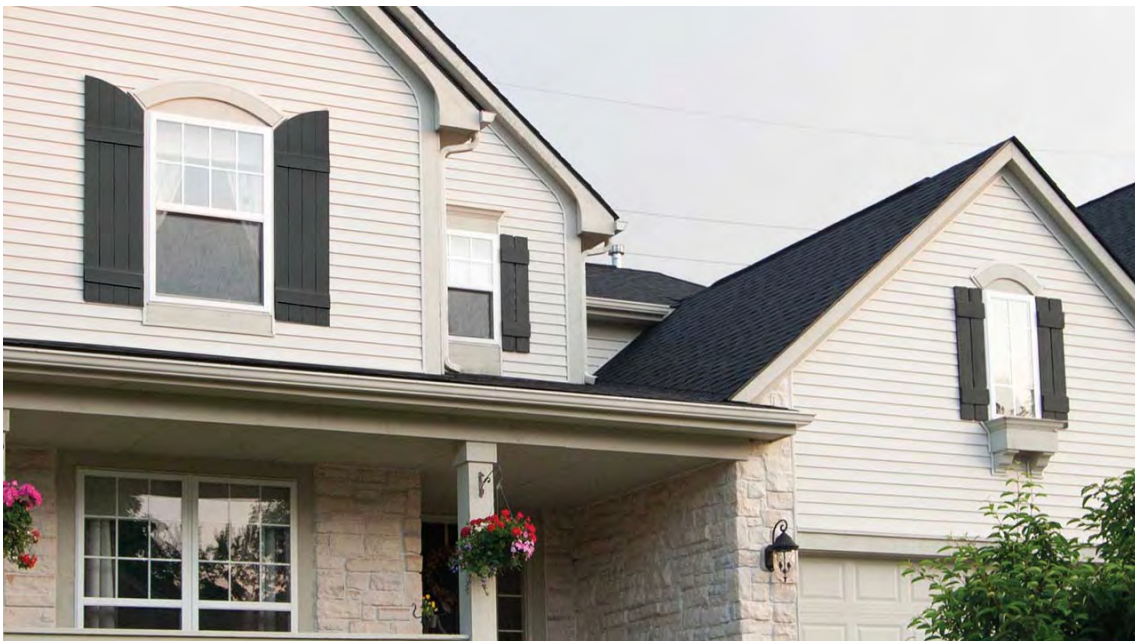

PICTURED : 4 BOARD JOINED AND W/ARCH TOP

Shutter Accessories



PICTURED IN CLASSIC BLUE #036

QUARTER ROUND ARCH TOP
SOLID
WIDTHS 14 1/2"

USE WITH 14 1/2" LOUVER
SHUTTER ONLY



PICTURED IN MIDNIGHT GREEN #122

QUARTER ROUND ARCH TOP
LOUVER
WIDTHS 14 1/2"

USE WITH 14 1/2" LOUVER
SHUTTER ONLY